



# STPS3045CT/CG/CR/CP/CPI/CW/CFP

## POWER SCHOTTKY RECTIFIER

### MAIN PRODUCT CHARACTERISTICS

$I_{F(AV)}$	2 x 15 A
$V_{RRM}$	45 V
$T_j(\text{max})$	175 °C
$V_F$	0.57 V

### FEATURES AND BENEFITS

- VERY SMALL CONDUCTION LOSSES
- NEGLIGIBLE SWITCHING LOSSES
- EXTREMELY FAST SWITCHING
- LOW THERMAL RESISTANCE
- INSULATED PACKAGE: TOP-3I  
Insulating voltage = 2500V RMS  
Capacitance = 12pF
- AVALANCHE CAPABILITY SPECIFIED

### DESCRIPTION

Dual center tap Schottky rectifier suited for SwitchMode Power Supply and high frequency DC to DC converters.

Packaged either in TO-220AB, TO-220FPAB, D<sup>2</sup>PAK, I<sup>2</sup>PAK, TO-247, SOT93 or TOP-3I, this device is especially intended for use in low voltage, high frequency inverters, free wheeling and polarity protection applications.

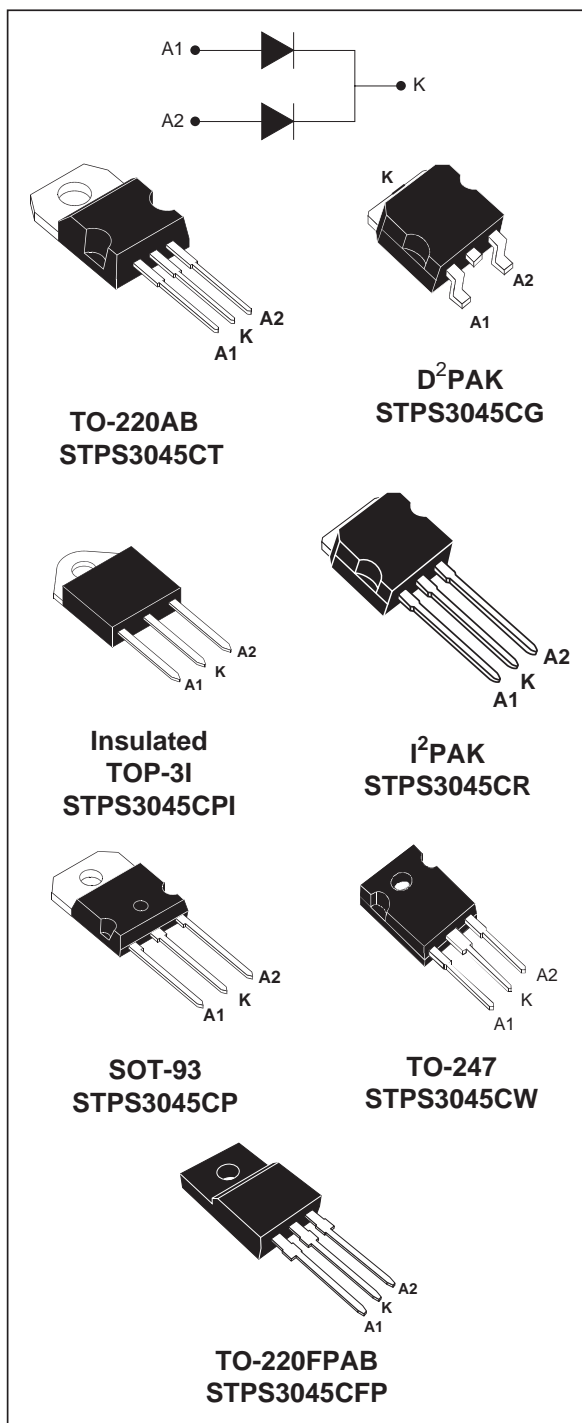

## STPS3045CT/CG/CR/CP/CPI/CW/CFP

### ABSOLUTE RATINGS (limiting values, per diode)

Symbol	Parameter			Value	Unit	
V <sub>RRM</sub>	Repetitive peak reverse voltage			45	V	
I <sub>F(RMS)</sub>	RMS forward current			30	A	
I <sub>F(AV)</sub>	Average forward current δ = 0.5	TO-220AB / D <sup>2</sup> PAK / I <sup>2</sup> PAK / SOT-93 / TO-247	T <sub>c</sub> = 155°C	Per diode Per device	15 30	A
		TO-220FPAB	T <sub>c</sub> = 130°C			
		TOP-3I	T <sub>c</sub> = 150°C			
I <sub>FSM</sub>	Surge non repetitive forward current		t <sub>p</sub> = 10 ms sinusoidal	220	A	
I <sub>RRM</sub>	Repetitive peak reverse current		t <sub>p</sub> = 2 μs square F = 1kHz	1	A	
I <sub>RSM</sub>	Non repetitive peak reverse current		t <sub>p</sub> = 100 μs square	3	A	
P <sub>ARM</sub>	Repetitive peak avalanche power		t <sub>p</sub> = 1μs T <sub>j</sub> = 25°C	6000	W	
T <sub>stg</sub>	Storage temperature range			-65 to +175	°C	
T <sub>j</sub>	Maximum operating junction temperature *			175	°C	
dV/dt	Critical rate of rise of reverse voltage			10000	V/μs	

\* :  $\frac{dP_{tot}}{dT_j} < \frac{1}{R_{th(j-a)}}$  thermal runaway condition for a diode on its own heatsink

### THERMAL RESISTANCES

Symbol	Parameter			Value	Unit
R <sub>th(j-c)</sub>	Junction to case	TO-220AB / D <sup>2</sup> PAK / I <sup>2</sup> PAK	Per diode Total	1.60 0.85	°C/W
		SOT-93 / TO-247	Per diode Total	1.5 0.8	
		TO-220FPAB	Per diode Total	4 3.2	
		TOP-3I	Per diode Total	2.2 1.6	
R <sub>th(c)</sub>		TO-220AB / D <sup>2</sup> PAK / I <sup>2</sup> PAK SOT-93 / TO-247	Coupling	0.10	
		TO-220FPAB	Coupling	2.5	
		TOP-3I	Coupling	1.0	

When the diodes 1 and 2 are used simultaneously:

$$\Delta T_j (\text{diode 1}) = P (\text{diode 1}) \times R_{th(j-c)} (\text{per diode}) + P (\text{diode 2}) \times R_{th(c)}$$

### STATIC ELECTRICAL CHARACTERISTICS (Per diode)

Symbol	Parameter	Tests Conditions		Min.	Typ.	Max.	Unit
I <sub>R</sub> *	Reverse leakage current	T <sub>j</sub> = 25°C	V <sub>R</sub> = V <sub>RRM</sub>			200	μA
		T <sub>j</sub> = 125°C			11	40	mA
V <sub>F</sub> *	Forward voltage drop	T <sub>j</sub> = 125°C	I <sub>F</sub> = 15 A		0.5	0.57	V
		T <sub>j</sub> = 25°C	I <sub>F</sub> = 30 A			0.84	
		T <sub>j</sub> = 125°C	I <sub>F</sub> = 30 A		0.65	0.72	

Pulse test : \* t<sub>p</sub> = 380 μs, δ < 2%

To evaluate the conduction losses use the following equation :

$$P = 0.42 \times I_{F(AV)} + 0.01 I_{F(RMS)}^2$$

**Fig. 1:** Average forward power dissipation versus average forward current (per diode).

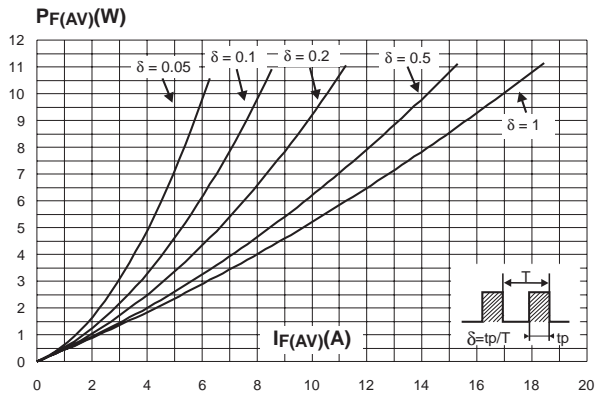

**Fig. 2:** Average current versus ambient temperature ( $\delta = 0.5$ , per diode).

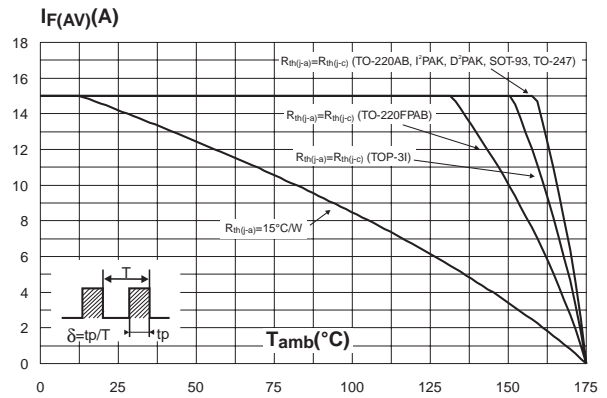

**Fig. 3:** Normalized avalanche power derating versus pulse duration.

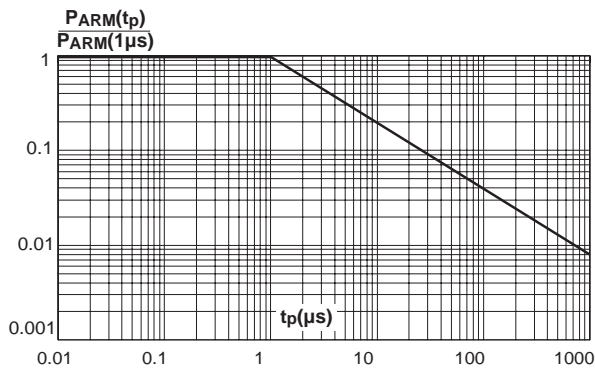

**Fig. 4:** Normalized avalanche power derating versus junction temperature.

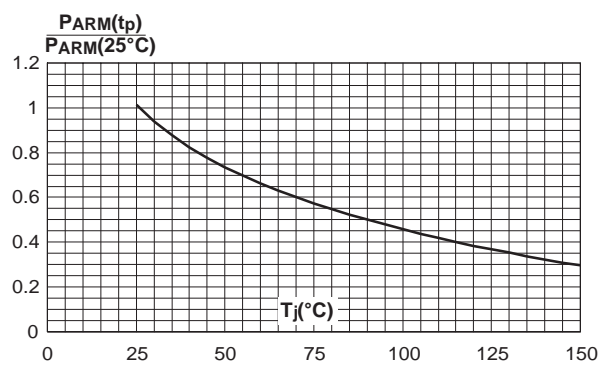

**Fig. 5-1:** Non repetitive surge peak forward current versus overload duration (maximum values, per diode).

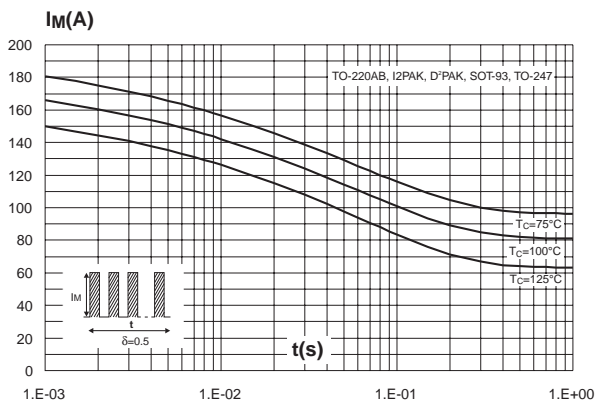

**Fig. 5-2:** Non repetitive surge peak forward current versus overload duration (maximum values, per diode).

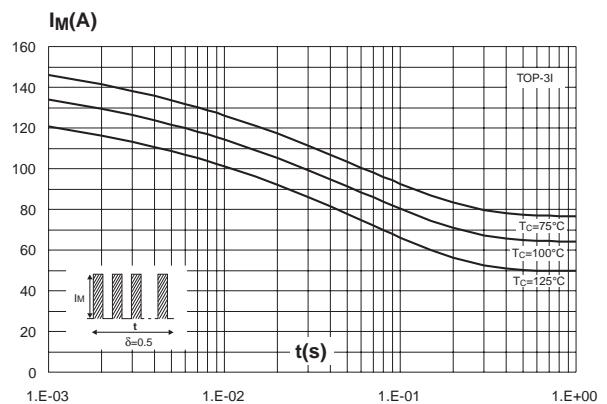

**Fig. 5-3:** Non repetitive surge peak forward current versus overload duration (maximum values, per diode).

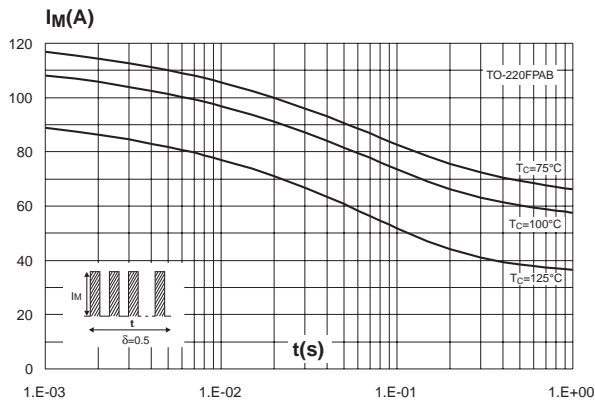

**Fig. 6-1:** Relative variation of thermal transient impedance junction to case versus pulse duration.

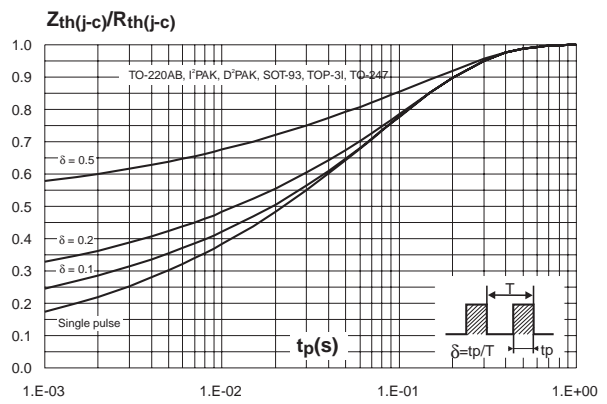

**Fig. 6-2:** Relative variation of thermal transient impedance junction to case versus pulse duration.

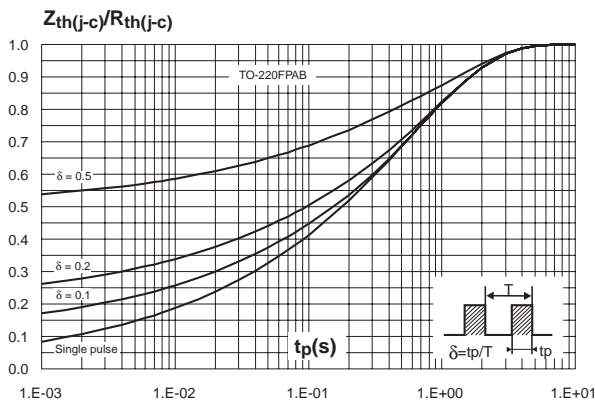

**Fig. 7:** Reverse leakage current versus reverse voltage applied (typical values, per diode).

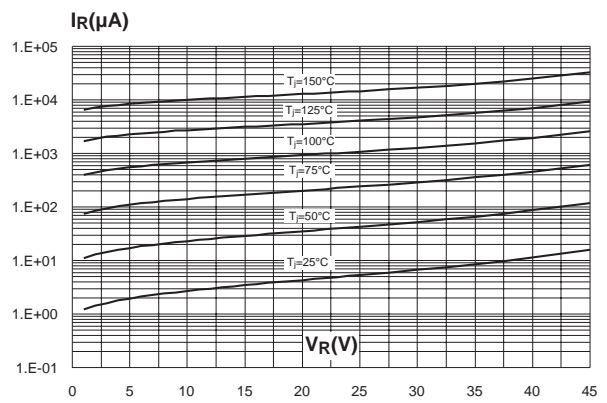

**Fig. 8:** Junction capacitance versus reverse voltage applied (typical values, per diode).

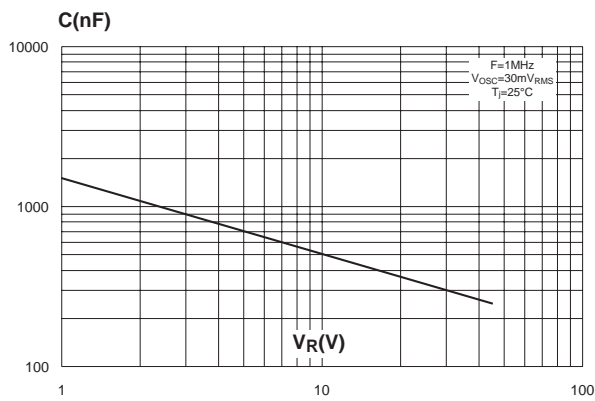

**Fig. 9:** Forward voltage drop versus forward current (maximum values, per diode).

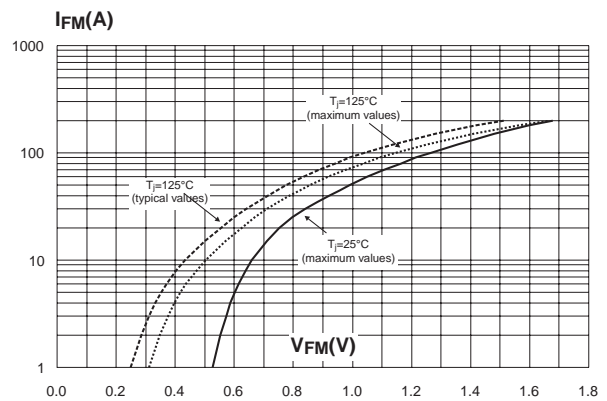

**Fig. 10:** Thermal resistance junction to ambient versus copper surface under tab (epoxy printed board FR4, Cu=35µm).

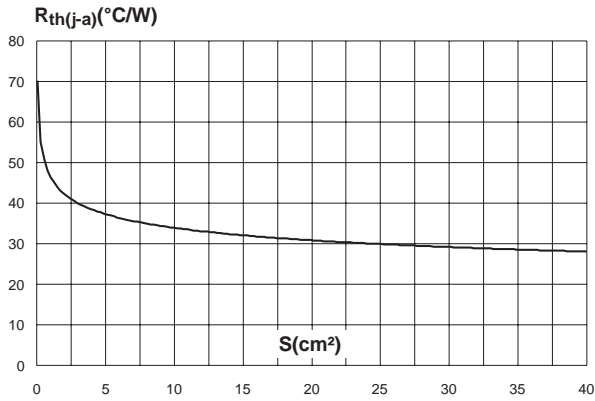

**PACKAGE MECHANICAL DATA**  
TO-220AB

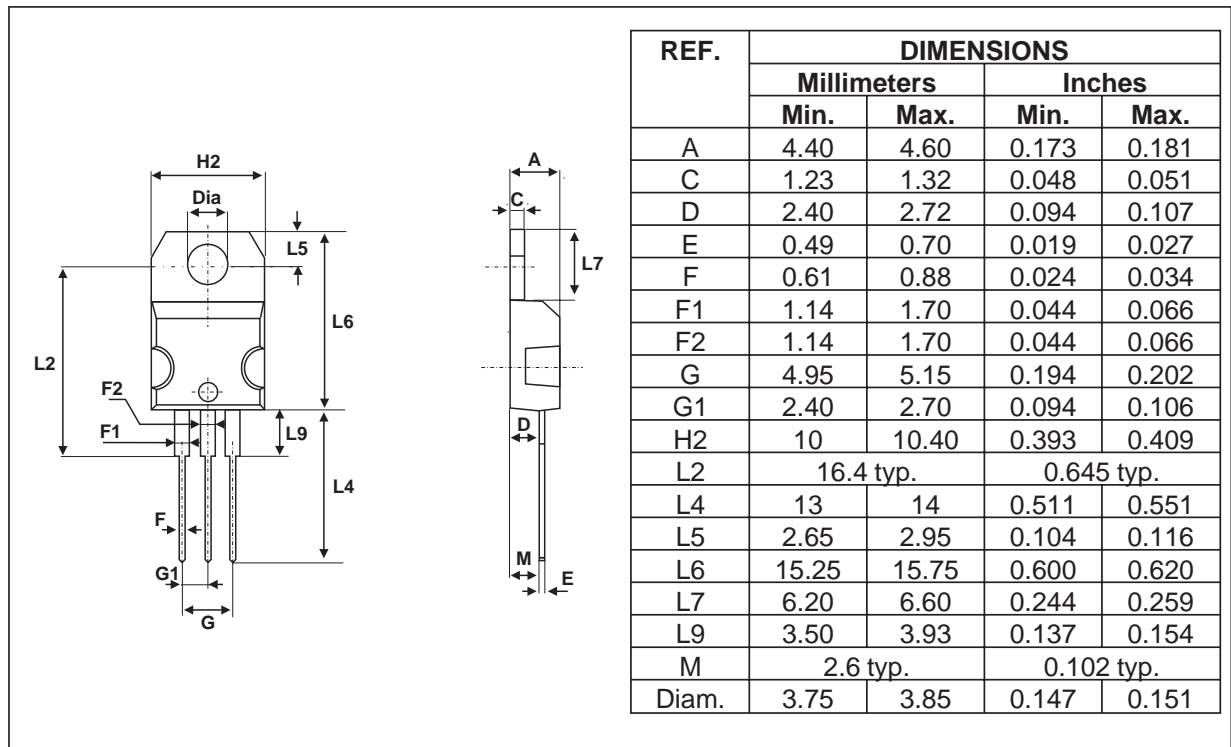

PACKAGE MECHANICAL DATA  
I<sup>2</sup>PAK

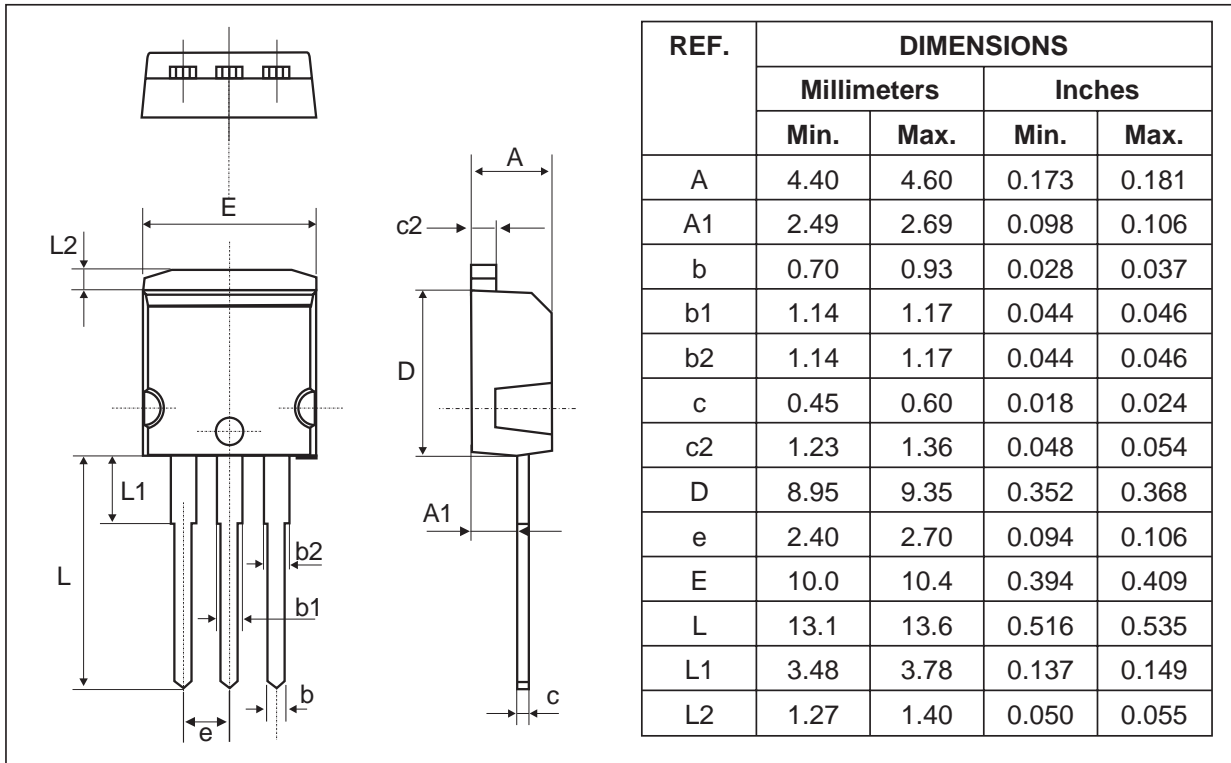

PACKAGE MECHANICAL DATA  
TOP-31 (isolated)

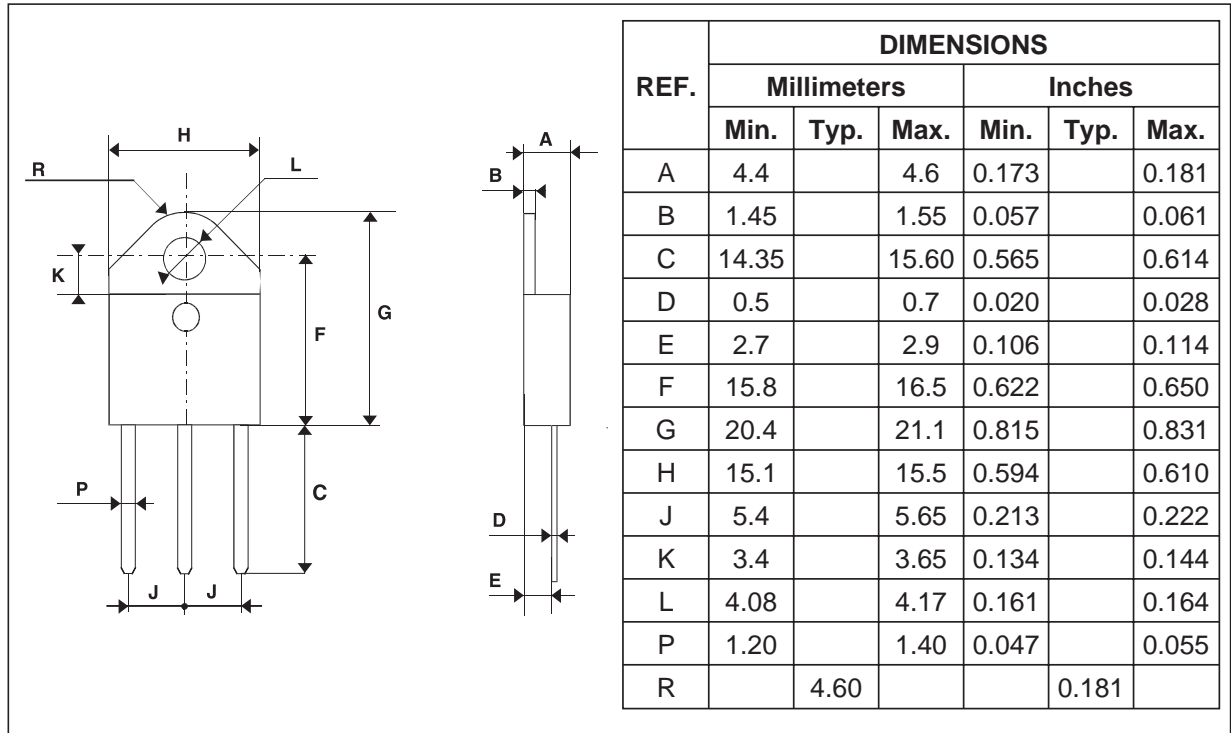

**PACKAGE MECHANICAL DATA**  
D<sup>2</sup>PAK

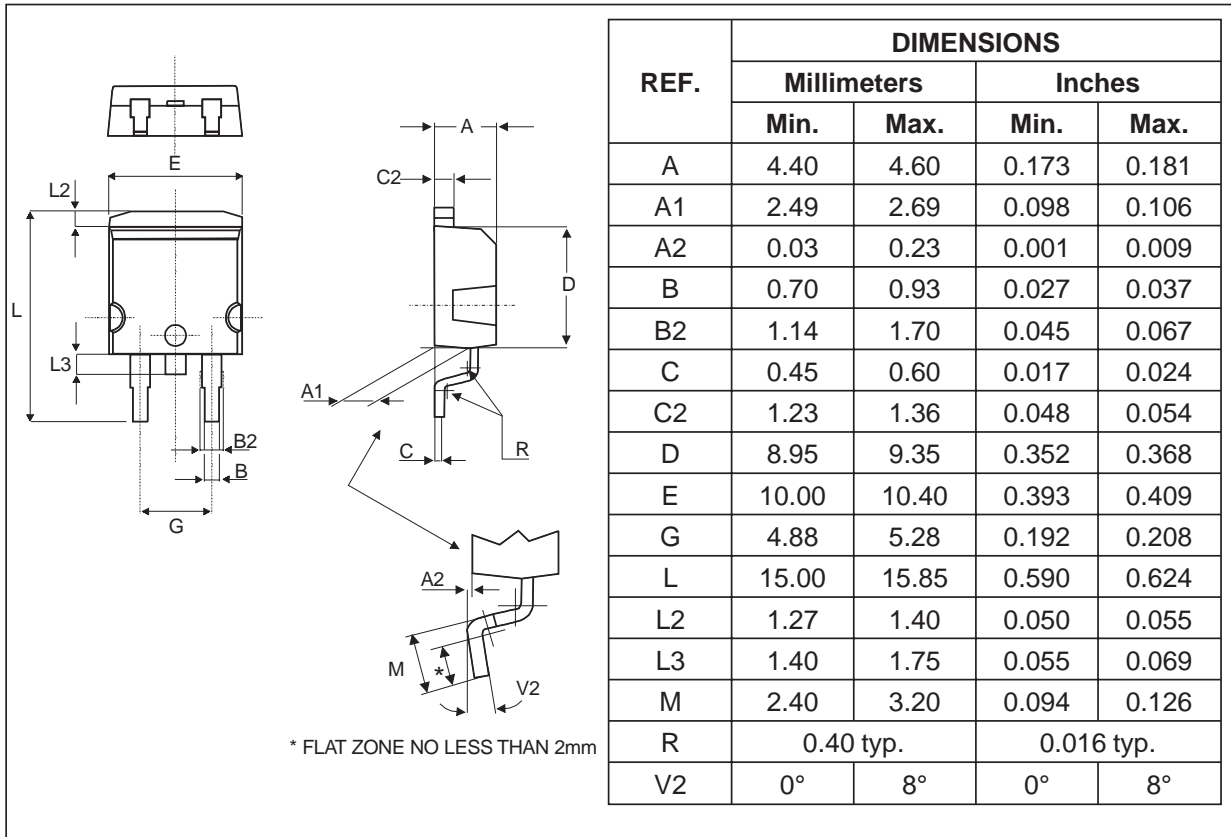

**FOOTPRINT DIMENSIONS** (in millimeters)

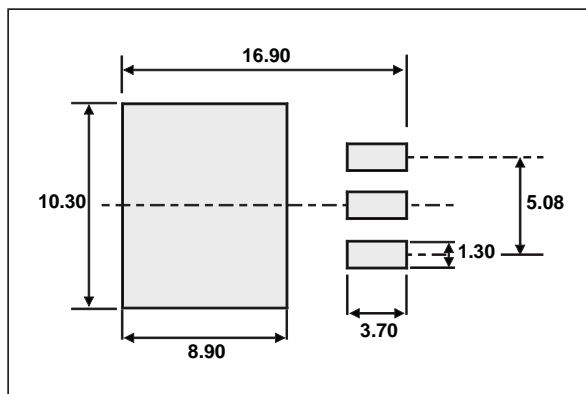

**STPS3045CT/CG/CR/CP/CPI/CW/CFP**

**PACKAGE MECHANICAL DATA**  
TO-247

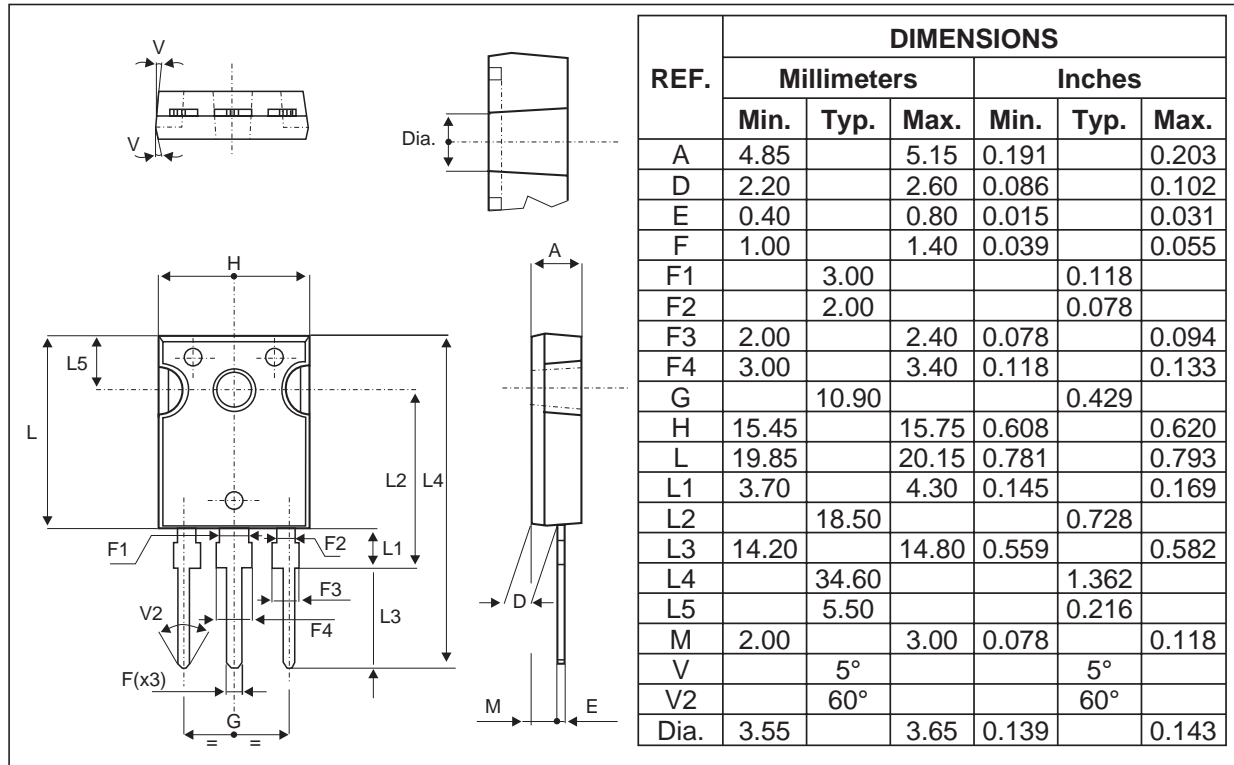

**PACKAGE MECHANICAL DATA**  
SOT-93

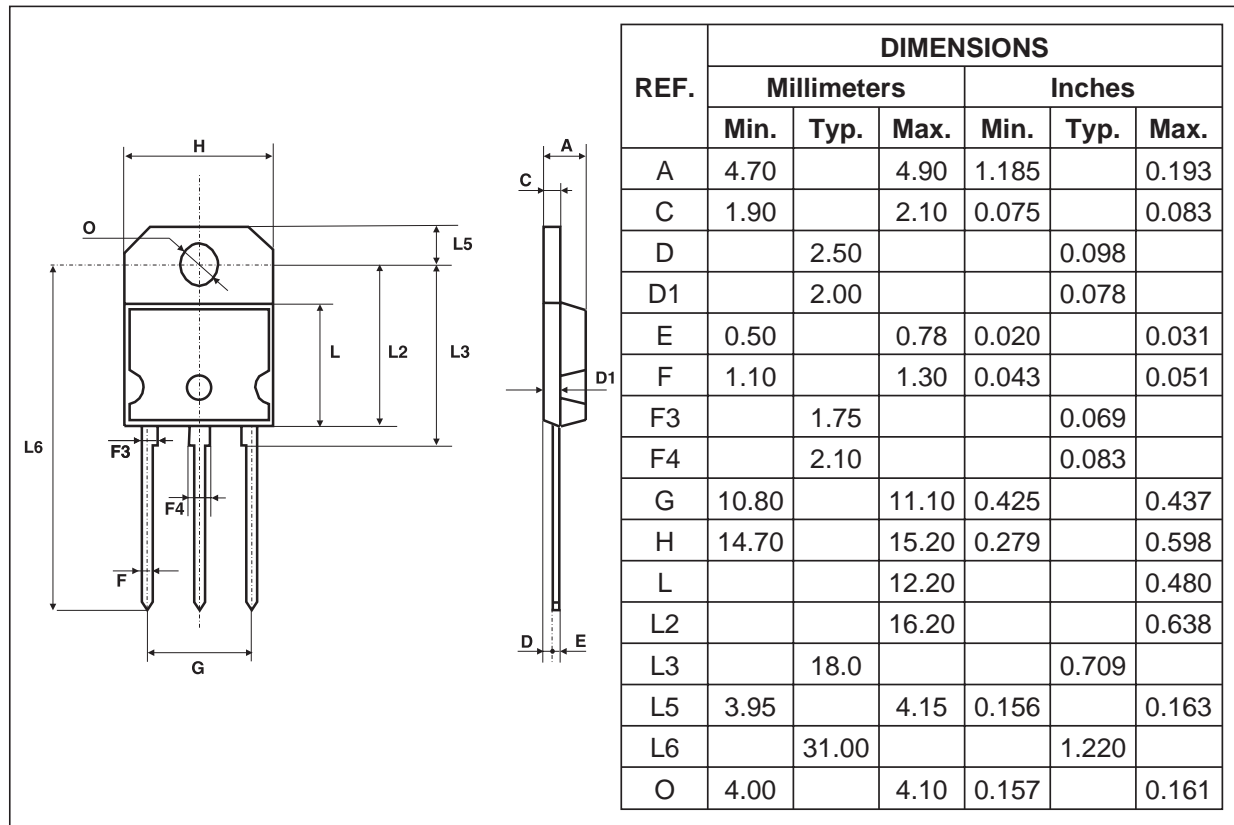



**PACKAGE MECHANICAL DATA**  
TO-220FPAB

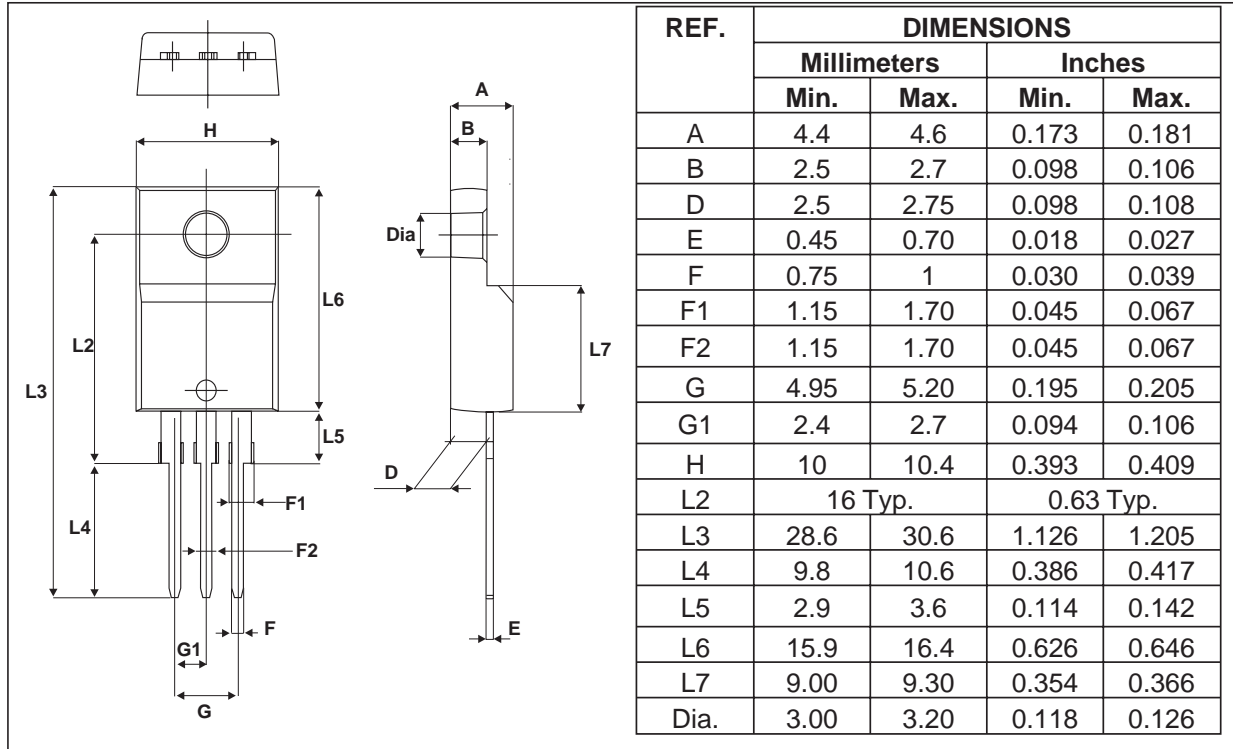

Type	Marking	Package	Weight	Base qty	Delivery mode
STPS3045CT	STPS3045CT	TO-220AB	2.23 g.	50	Tube
STPS3045CG	STPS3045CG	D <sup>2</sup> PAK	1.48 g.	50	Tube
STPS3045CG-TR	STPS3045CG	D <sup>2</sup> PAK	1.48 g.	1000	Tape & reel
STPS3045CR	STPS3045CR	I <sup>2</sup> PAK	1.48 g.	50	Tube
STPS3045CP	STPS3045CP	SOT-93	3.97 g.	30	Tube
STPS3045CPI	STPS3045CPI	TOP-3I	4.46 g.	120	Bulk
STPS3045CW	STPS3045CW	TO-247	4.46 g.	30	Tube
STPS3045CFP	STPS3045CFP	TO-220FPAB	2.0 g.	50	Tube

- Cooling method: by conduction (C)
- Recommended torque value (SOT-93, TOP-3I, TO-247): 0.8 N.m.
- Recommended torque value (TO-220AB): 0.55 N.m.
- Maximum torque value (SOT-93, TOP-3I, TO-247): 1.0 N.m.
- Maximum torque value (TO-220AB): 0.7 N.m.

Information furnished is believed to be accurate and reliable. However, STMicroelectronics assumes no responsibility for the consequences of use of such information nor for any infringement of patents or other rights of third parties which may result from its use. No license is granted by implication or otherwise under any patent or patent rights of STMicroelectronics. Specifications mentioned in this publication are subject to change without notice. This publication supersedes and replaces all information previously supplied. STMicroelectronics products are not authorized for use as critical components in life support devices or systems without express written approval of STMicroelectronics.

The ST logo is a registered trademark of STMicroelectronics  
 © 2003 STMicroelectronics - Printed in Italy - All rights reserved.  
 STMicroelectronics GROUP OF COMPANIES  
 Australia - Brazil - Canada - China - Finland - France - Germany  
 Hong Kong - India - Israel - Italy - Japan - Malaysia - Malta - Morocco - Singapore  
 Spain - Sweden - Switzerland - United Kingdom - United States.

